



KEY TOOL PLUS

User Manual



Xhorse APP

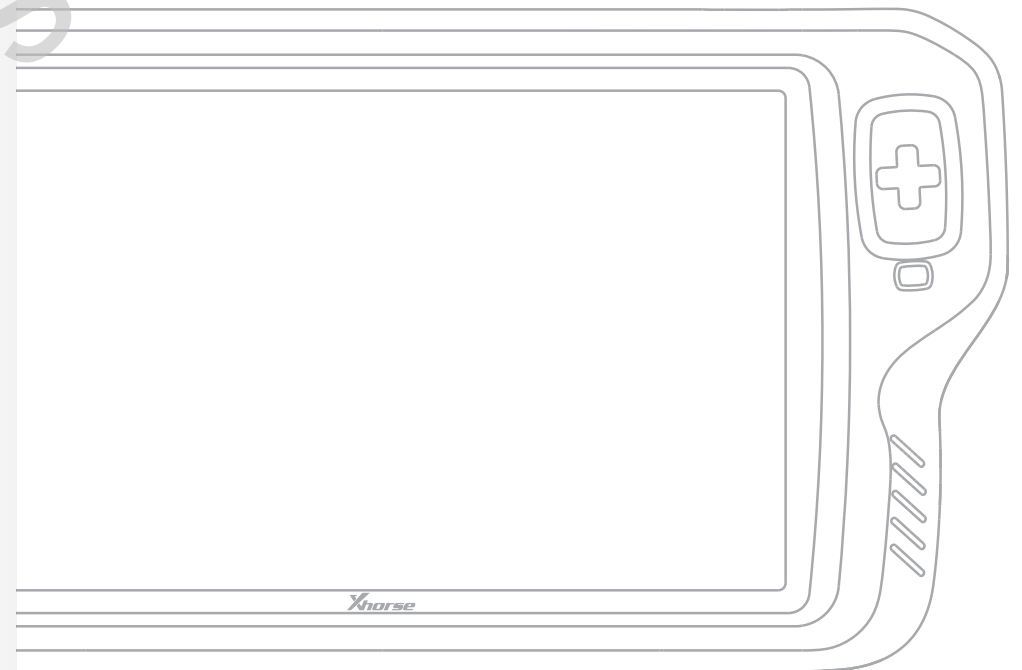

*Read this user manual carefully before using the device.



E X T R E M E
H O R S E P O W E R

Thank you
for choosing Xhorse device.

www.xhorsevdi.com

Contents

1 Disclaimer	01	8 Immo Data Tool	30
2 Safety Precaution	01	8.1 Car models support list	
3 Product List	01	8.2 Magotan/CC 48 transponder File Make Key	
4 KEY TOOL PLUS Overview	03	8.3 File management	
4.1 Main interface		9 Extended Function: Cutting Key	33
4.2 Ports and accessories		9.1 How to switch and connect the key cutting machine	
4.3 Specifications		9.2 Introduction to key cutting machine functions	
5 OBD IMMO Programming	14	10 Settings	38
5.1 Overview		10.1 Select	
5.2 IMMO programming		10.2 WLAN connection	
5.3 Authorization code		10.3 Language setting	
5.4 E.g. Honda Accord immo programming		10.4 APP setting	
6 Remote and Transponder	18	10.5 System setting	
6.1 Remote generation & clone		10.6 Service/privacy policy	
6.2 Transponder read, generation & clone		10.7 About us	
6.3 Special functions		11 Warranty and After-sales Service	40
7 PROG	25		
7.1 Overview			
7.2 EEPROM Reading and Writing			
7.3 BMW FRM module programming(Solder-Free)			
7.4 LANDROVER RFA programming(Solder-Free)			
7.5 PORSCHE BCM programming(Solder-Free)			

1 Disclaimer

We congratulate you on your choice of KEY TOOL PLUS developed by Shenzhen Xhorse Electronics Co., Ltd(Xhorse). Your new KEY TOOL PLUS has passed stringent controls before it's released for sale. To ensure it operates perfectly, we recommend that you follow the advice given in this instruction.

- This device is used only by the locksmiths that get authorization from the car owner for car remote matching purposes following relevant laws and regulations. We do not endorse illegal use.
- Any risk follows the illegal use of this document and Xhorse KEY TOOL PLUS will be the user's responsibility. Xhorse does not share it.
- Xhorse does not assume any direct, indirect and incidental compensation for damage or any other indirect economical losses.

2 Safety Precaution

For your own safety and the safety of others, and to prevent damage to the device and vehicles upon which it is used, it is important that the safety instructions presented throughout this manual be read and understood by all persons operating or coming into contact with the device.

- Do not place the device in a strong electromagnetic environment for strong electromagnetic interference may damage the device.
- Do not plug in the power supply that does not conform to the power standard (see Chapter 4.3).
- Turn off the device if you are not using it for a long time or when it's under maintenance.
- Do not place the device in a humid, oily or dusty environment.
- Do not press the device hard, drop the device, or expose the device to heavy sunlight.
- Keep the device out of the reach of babies and children.

3 Product List

KEY TOOL PLUS comes with the following items. If you are missing any of those, please contact your local dealer. For specific functions of all the accessories, please see Chapter 4.

No.	Items	Standard	Advanced	Description
1	KEY TOOL PLUS	•	•	KEY TOOL PLUS tablet
2	User Manual	•	•	Device instruction
3	Certification and warranty card	•	•	Certificate of conformity and warranty card
4	Charger	•	•	Fast charging plug
5	USB3.0 TYPE-C cable	•	•	USB charging cable
6	OBD_DB25 cable	•	•	OBD cable
7	OBD_KIA_10 connector	•	•	OBD connector
8	OBD_KIA_20 connector	•	•	OBD connector
9	OBD_HONDA_3 connector	•	•	OBD adapter
10	Remote_PS2 programming cable	•	•	Remote programming cable
11	Transponder box	•	•	Transponder storage box
12	Prog_DB15_15 cable	–	•	DB15 adapter for Programming
13	Prog_EEPROM adapter	–	•	EEPROM reading & writing adapter
14	Benz_IR reader	–	•	Infrared Adapter for Benz
15	Benz_NEC1 adapter	–	•	Adapter 1 for Benz NEC chip
16	BENZ_NEC2 adapter	–	•	Adapter 2 for Benz NEC chip
17	BENZ_NEC3 adapter	–	•	Adapter 3 for Benz NEC chip
18	BENZ_power adapter	–	•	BENZ non-removal adapter
19	9s12xE cable	–	•	Cable for reading and writing Motorola 9S12 series chip
20	MCU cable	–	•	Cable for reading and writing MCU chip

4 KEY TOOL PLUS Overview

KEY TOOL PLUS provides an all-in-one automotive security solution for locksmiths. The device combines immobilizer matching, remote generation, transponder clone, File Make Key and reading & writing vehicle module data. Besides, it is available to control key cutting machines developed by Xhorse.

4.1 Main interface

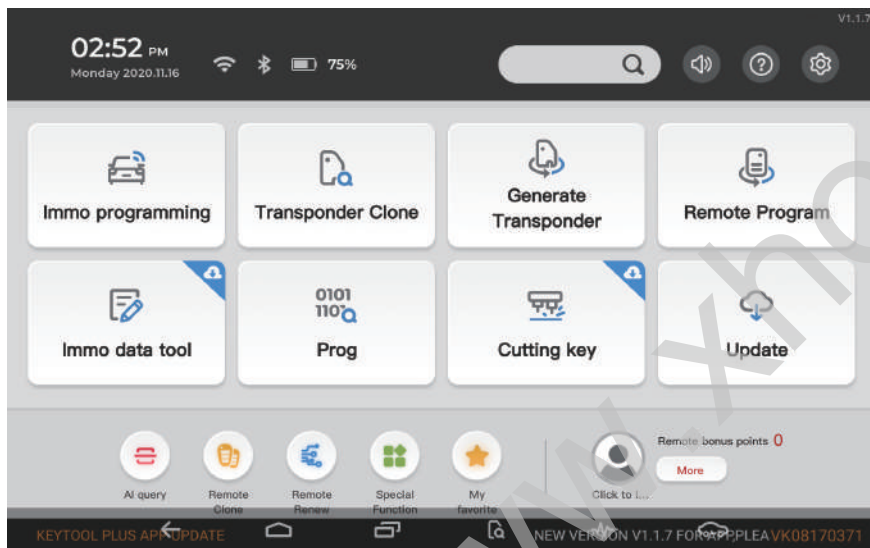

4.1.1 Icon illustration



WIFI and Bluetooth: Click the icon for the WIFI and Bluetooth connection settings.



Searching icon: Type in the car model to quickly search its programming options on remote, key, transponder and immo programming. See Fig. 4.11

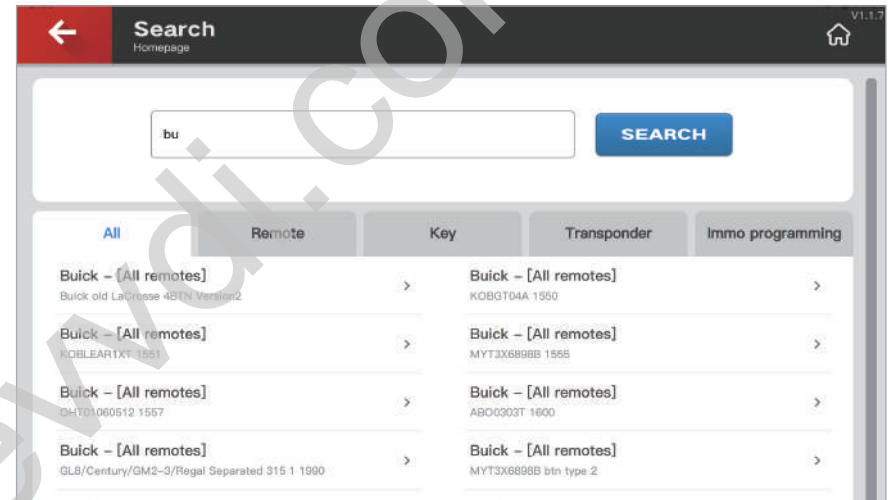

Fig.4.11



News (Message) center: Click the icon to get the latest update information. See Fig. 4.12

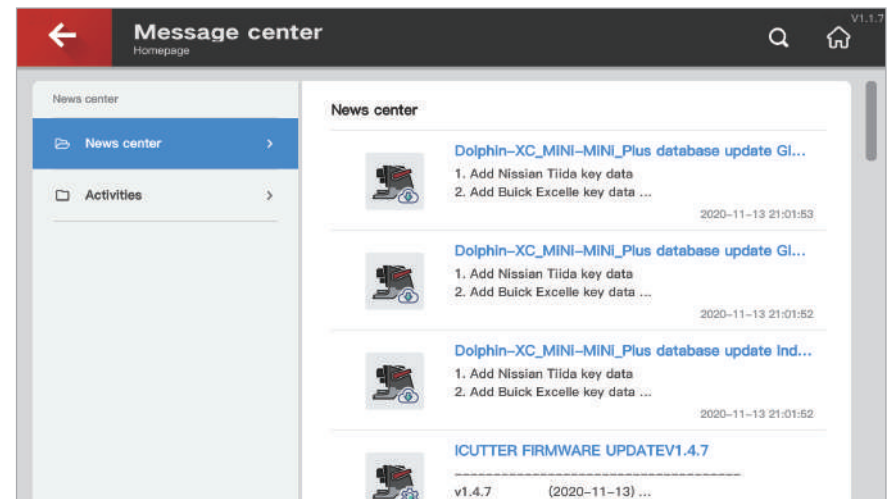



Fig.4.12

 **Help center:** Click the icon to find helpful technical guidance. See Fig. 4.1.3

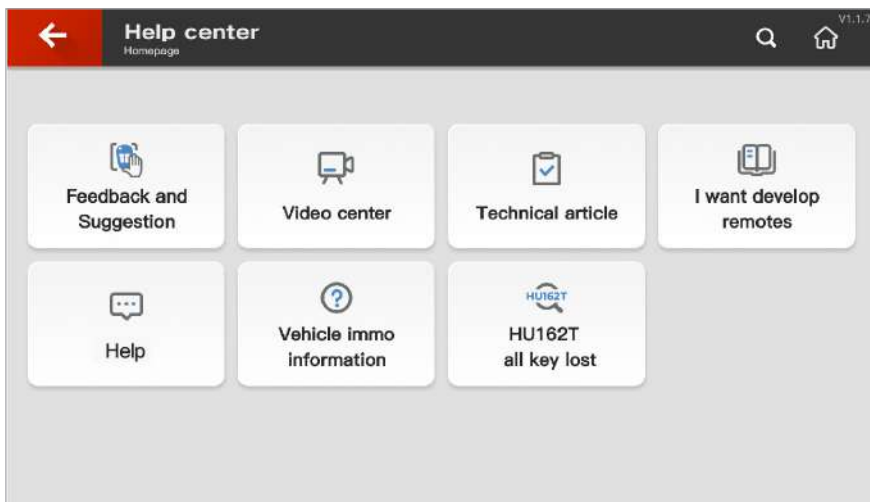





Fig.4.1.3

 **Feedback and suggestion**
Your valuable feedback and suggestion will be highly appreciated.

 **Video center**
Tutorial videos are provided here.

 **Technical article**
Technical guidance articles and device detailed information are provided here.

 **I want to develop remotes**
You can apply for developing remotes that you need but are not supported at the moment by the device.









 **Help**
Common questions and answers about the device are provided here.

 **Vehicle immo information**
Information about vehicle immo programming are provided here.

 **HU162T all key lost**
HU162T data, Volkswagen new model key blank, are provided here.

 **Settings:** click the icon to open the general setting interface (see Chapter 10).

4.1.2 Main function menu

-  **Immo Programming**
Vehicle OBD immo programming menu (see Chapter 5)
-  **Transponder Clone**
Read and clone vehicle transponders (see Chapter 6)
-  **Generate Transponder**
Vehicle remote transponder generation (see Chapter 6)
-  **Remote Program**
Vehicle remote generation (see Chapter 6)
-  **Immo Data Tool**
Vehicle immo programming by File Make Key function (see Chapter 8)
-  **PROG**
Read & write EEPROM data, ECU and other car modules data (see Chapter 7)
-  **Cutting Key**
Complete key cutting work with Xhorse key cutting machines (see Chapter 9)
-  **Update**
System update center (see Fig. 4.1.4)

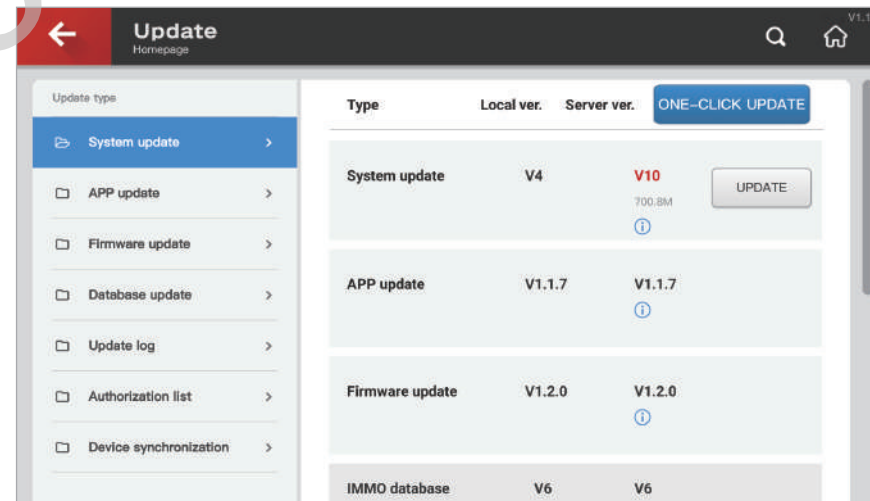

Fig.4.1.4

4.1.3 Shortcut function

AI query: Scan the VIN code of the vehicle, it's able to automatically show the operation options like detailed information, cutting key, remote program, immo programming and immo data tool. See Fig. 4.1.5

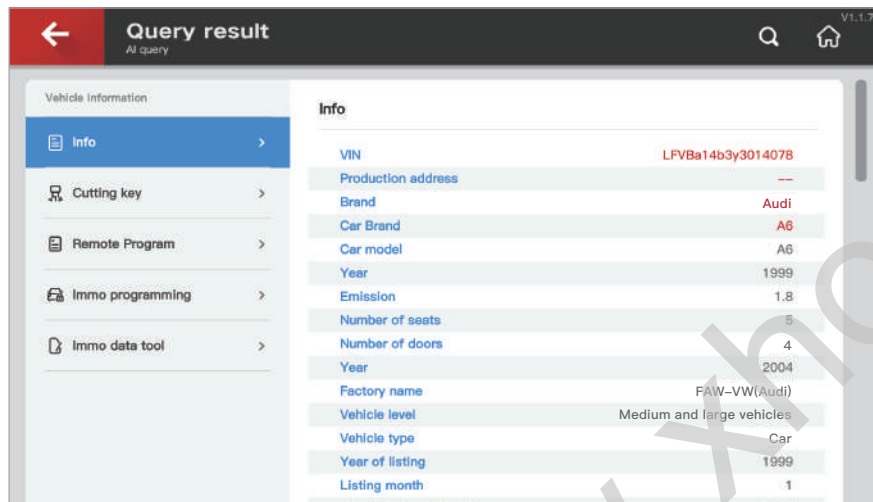

Fig.4.1.5

- Remote clone:** Frequency detection and remote clone (see Chapter 6).
- Remote renew:** Unlock the remote which was programmed (see Chapter 6).
- Special function:** The function is commonly used for remote programming (see Chapter 6).

My favorite: Users can bookmark vehicle remotes and key blanks to quickly access their favorites with one click next time. See Fig. 4.1.6

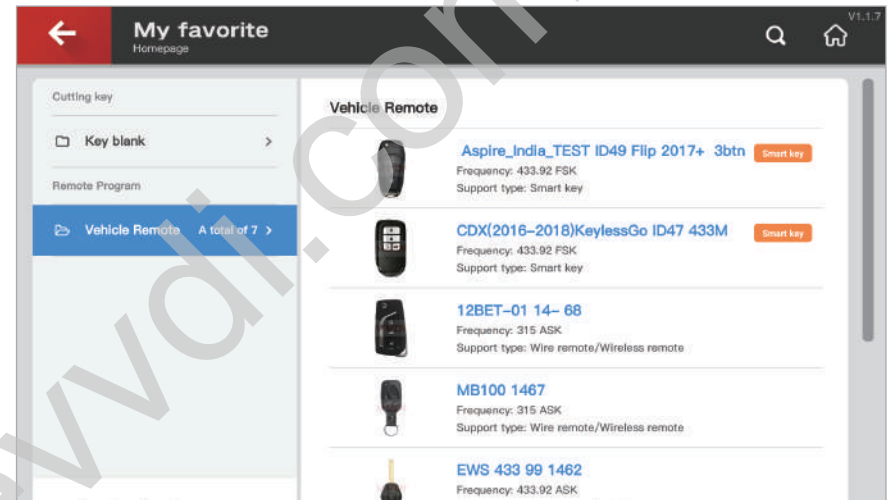

Fig.4.1.6

My account: Users can check the bonus points details, combine and unbind device and complete the real-name verification. See Fig. 4.1.7

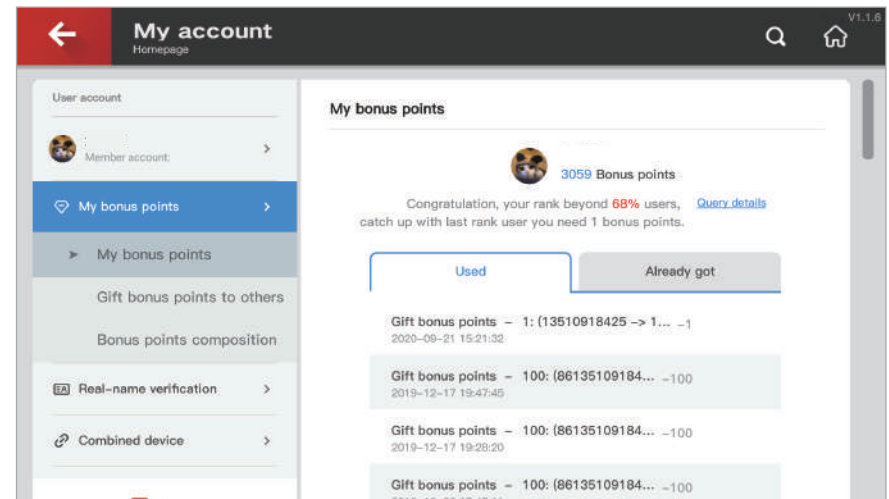

Fig.4.1.7

Synchronization: Users can synchronize tokens and collect bonus points. See Fig. 4.1.8

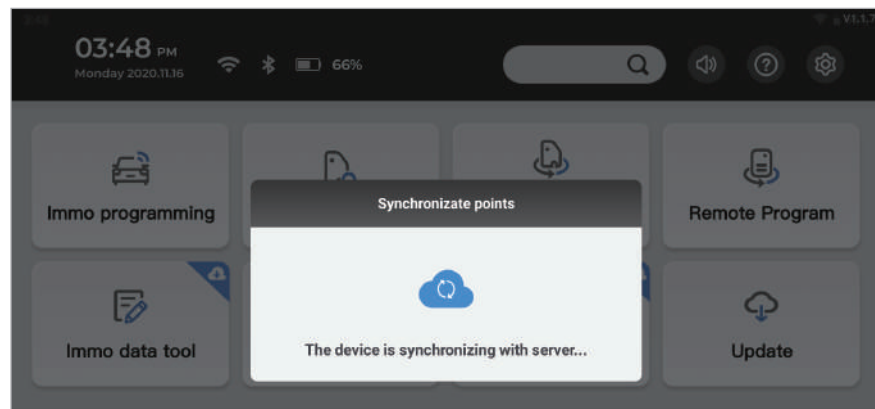

Fig.4.1.8

Update notification bar: The update information of the device.

Serial number: The serial number of the device.

4.2 Ports and accessories

4.2.1 Name of device ports



Fig. 4.2.1 Front View

- ① **Screen**
- ② **Light sensor**—detect the brightness in the current environment
- ③ **Detection coil** (including 125K low, 13.56M Medium, 300–900M high frequency)
 - Support reading, writing and cloning common immo transponder
 - Support reading common ID transponders
 - Support reading common IC transponders
 - Support frequency detection of common vehicle remotes
- ④ **Immo transponder placement hole**—for vehicle immo transponders

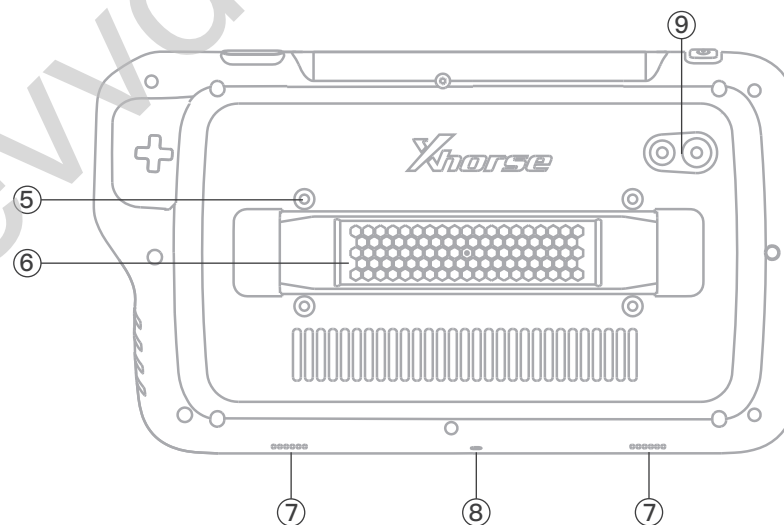
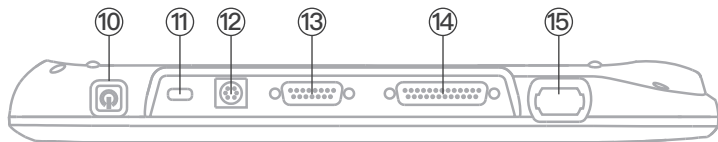

Fig. 4.2.2 Back View

- ⑤ **Screw hole for tablet support**(Optional accessory)
- ⑥ **Hand strap holder**
- ⑦ **Speaker**
- ⑧ **Microphone**
- ⑨ **Camera & flashlight**



- ⑩ On / Off / Screen Lock
- ⑪ USB charging port——support standard fast charge adapter and standard Type-C port DC-5V input
- ⑫ PS2 port for remote generation
- ⑬ DB15 port——support standard & optional programming adapters with DB15 port
- ⑭ DB25 port for OBD immo programming
- ⑮ Benz Infrared (IR) port——support IR read Benz FBS3 & FBS4 smart key
——support Benz IR reader

4.2.2 Accessories

- ① Charger & USB cable

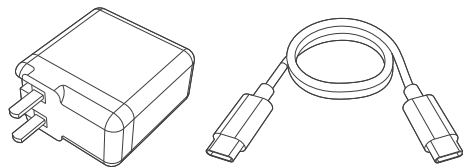

- ② OBD_DB25 cable
apply for connecting vehicle OBD port

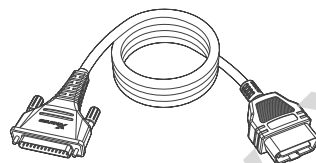

- ③ OBD connector
apply for connecting non-OBD II vehicle choose the fitting connector depending on the car models and interface

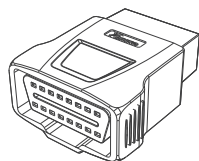

KIA 20 pin

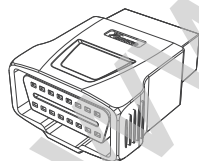

KIA 10 pin

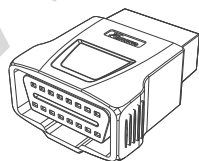

KIA 3 pin

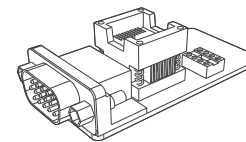

- ④ EEPROM adapter——Adapter for programming

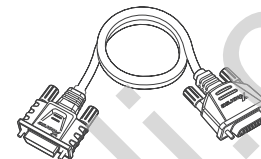

- ⑤ DB15_15 connector——Connector for programming

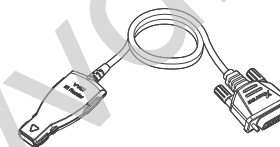

- ⑥ Benz IR reader——Infrared data collection adapter

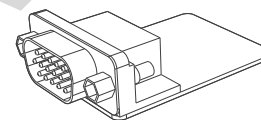

- ⑦ Benz adapter——NEC adapter
NEC adapters——We provide 3 different adapters depending on the versions of Benz NEC smart remote.

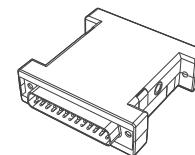

- ⑧ BENZ_power adapter——BENZ non-removal adapter

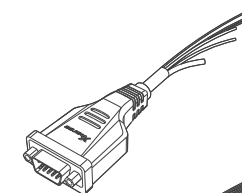

- ⑨ 9s12xE——Cable for reading and writing Motorola 9S12 series chip

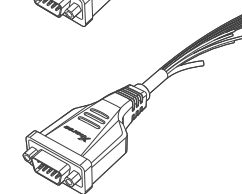

- ⑩ MCU——Cable for reading and writing MCU chip

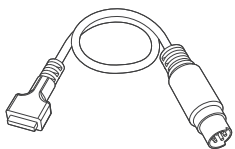

⑪ Remote programming cable

4.3 Specifications

Name	Specifications
Operating system	Android 9.0
Processor	8-Core 4xCortex-A53 up to 2.3Ghz+4xCortex-A53 up to 1.8Ghz
Screen	10.1 inch, 1920*1200 resolution
memory	4GB LPDDR4X SDRAM + 128GB EMMC
Camera	13.0MP
Input voltage (USB)	5V/9V
Input voltage (OBD)	12V/24V
Charging current	9V/3A
Standby time	>7*24h
Battery	10000mAh
Working temperature	-20~55 °C
Storage temperature	-30~65 °C
Wireless port	WiFi/Bluetooth
Sensor	Light sensor
Dimension	320*181*34mm

5 OBD IMMO Programming

5.1 Overview

KEY TOOL PLUS can be connected to the car via OBD connection cable to complete OBD immo programming and other OBD functions on most common car models. Currently, KEY TOOL PLUS supports lots of car brands such as Benz, BMW, Audi, VW, Toyota, Honda, Mazda, Ford, Cadillac, Hyundai, Kia, Renault, Nissan, SEAT, Fiat, JEEP and Chrysler.

As shown in Fig. 5.1.1, in immo programming menu, users can select the car brands and car models according to the brand area. KEY TOOL PLUS supports immo programming/matching for over 20,000 car models around the world.

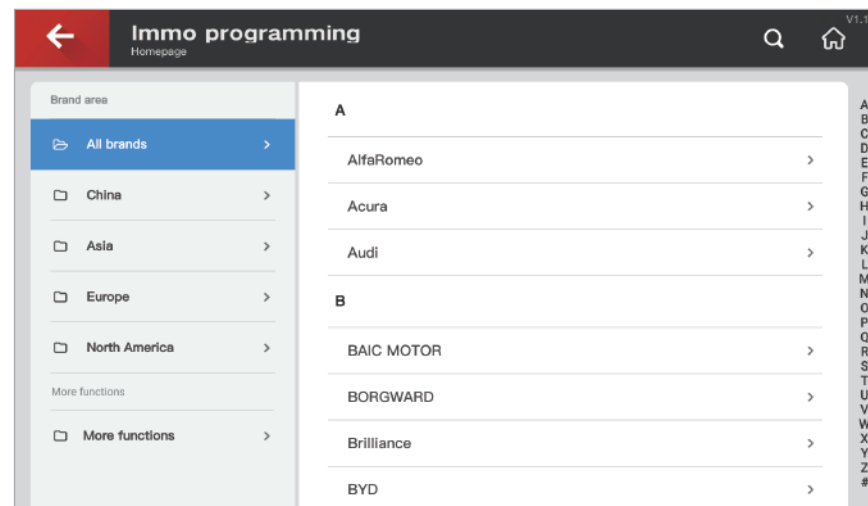

Fig.5.1.1

5.2 IMMO programming

After selecting your car model, the supported OBD programming menu will show up on the screen (see Fig. 5.2.1). For the same model, there might be a variety of immo systems. If users can't identify which system it is, users can try them out one by one, or detect it automatically. The common OBD functions include adding key, all key lost and remote clearing.

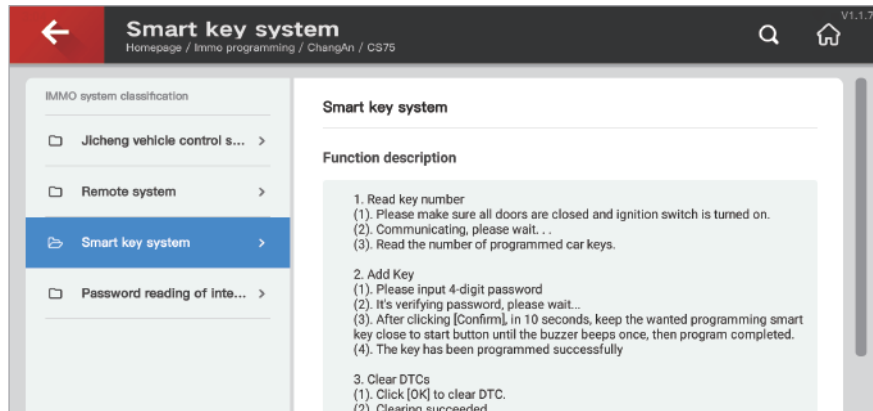

Fig.5.2.1

Read key number: You can acquire the number of remotes that the car currently has by OBD.

Add key: You can program the key by OBD.

Clear DTCs: You can clear DTCs generated while programming.

5.3 Authorization code

The authorization code is required while completing immo programming on some car models. KEY TOOL PLUS supports authorization code reading of some car models. For those codes it can't read, users need to ask for the authorized person to get the authorization code, then to complete the immobilizer programming.

For example, the PEUGEOT series car models need password reading. In Fig. 5.3.1, there are different methods to read passwords according to different car model years. Users can try them out one by one.

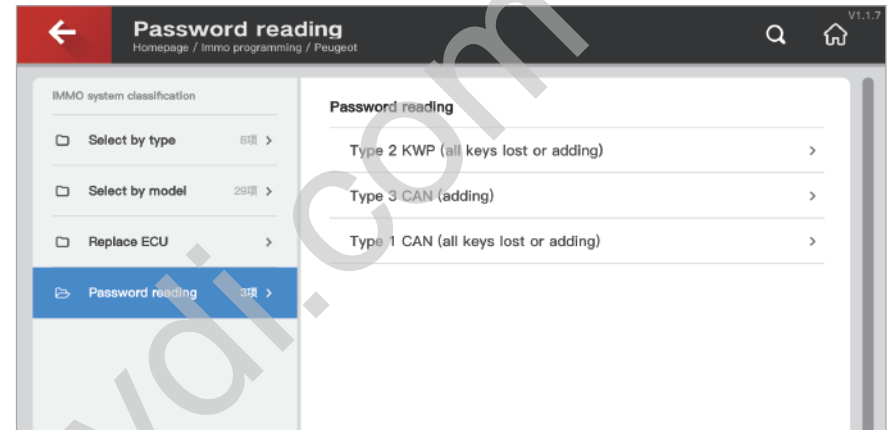

Fig.5.3.1

5.4 E.g. Honda Accord immo programming

Honda Accord, as a classic model, the immo systems and immo programming operations are different due to the different car model year. KEY TOOL PLUS supports immo programming of all models of Accord (see Fig. 5.4.1). Users can choose the smart key system and immobilizer system based on the immobilizer type of the original car.

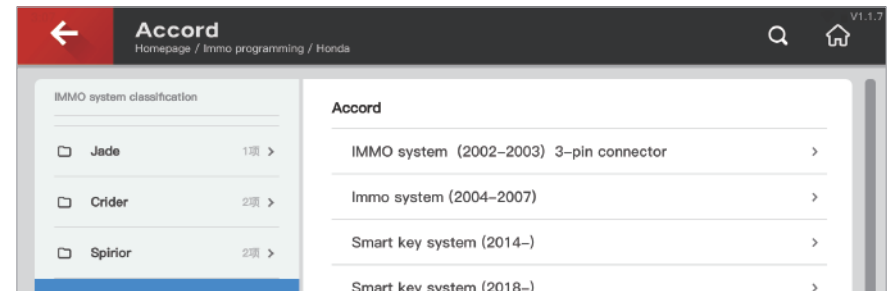

Fig.5.4.1

Note:

Smart key system: Original car key belongs to keyless entry.

Immobilizer system: Original car key belongs to flip key.

For example, for the 2020 10th generation Honda Accord, select the smart key system (2018-) option, follow the steps on the screen and get on the vehicle to complete the rest steps. See Fig. 5.4.2

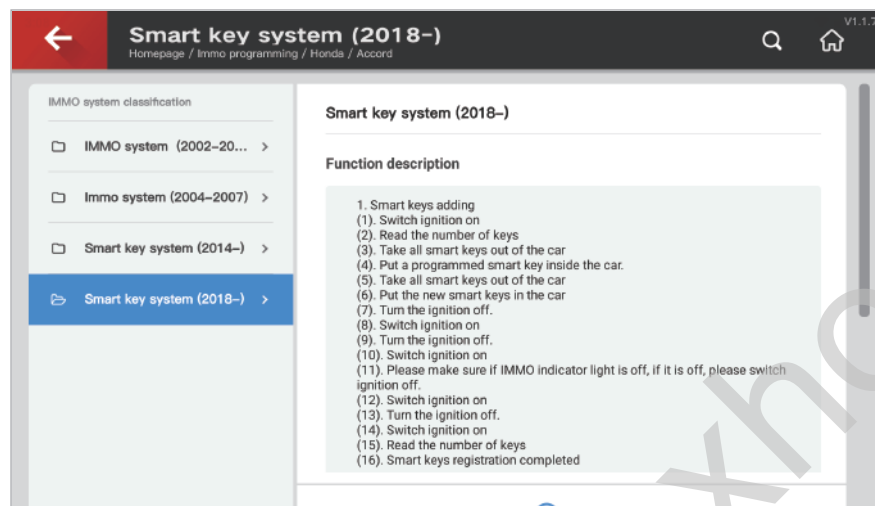

Fig.5.4.2

6 Remote and Transponder

KEY TOOL PLUS supports various functions such as remote generation, transponder clone and smart key generation for a variety of car models. Users can easily generate remotes for most car models by using Xhorse universal remotes on KEY TOOL PLUS.

6.1 Remote generation & clone

KEY TOOL PLUS supports remote generation for ordinary cars, smart key generation, frequency detection, remote clone for a variety of car models. More car models will be supported for free in the future.

In remote program, you can search the car brand based on the brand area on the left, via Q on the right, or in all brands. Besides, KEY TOOL PLUS also supports my favorites for your convenience as shown in Fig. 6.1.1.

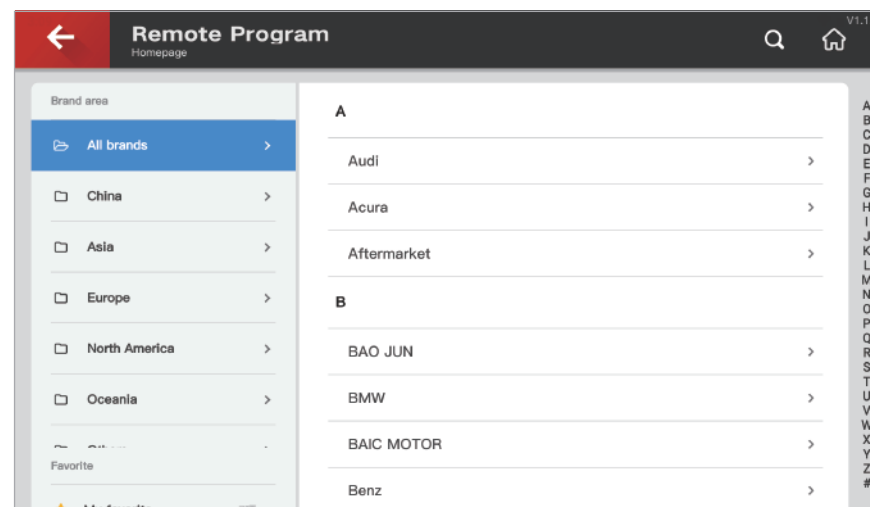

Fig.6.1.1

6.2 Transponder read, generation & clone

KEY TOOL PLUS has comprehensive programming functions covering transponder detection, clone and generation which supports most common transponders such as 11, 12, 13, 33, 42, 46, 4D, 48, 8A, 8C. It also supports Xhorse super transponder.

As shown in Fig. 6.2.1, KEY TOOL PLUS can precisely read the remote transponder as AUDI 5th generation and also read the remote reading status, remote frequency, synchronized mileage information of the vehicle.

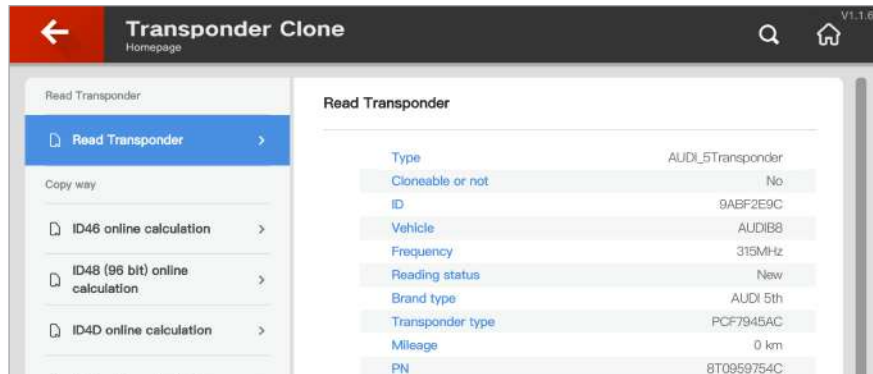

Fig.6.2.1

Some vehicle transponders can be directly cloned without any need to complete car matching in the car. As shown in Fig 6.2.2, users can copy all the transponder ID48. For example, all transponder ID48 of VW car models can be directly cloned online, no need to complete car matching in the car.

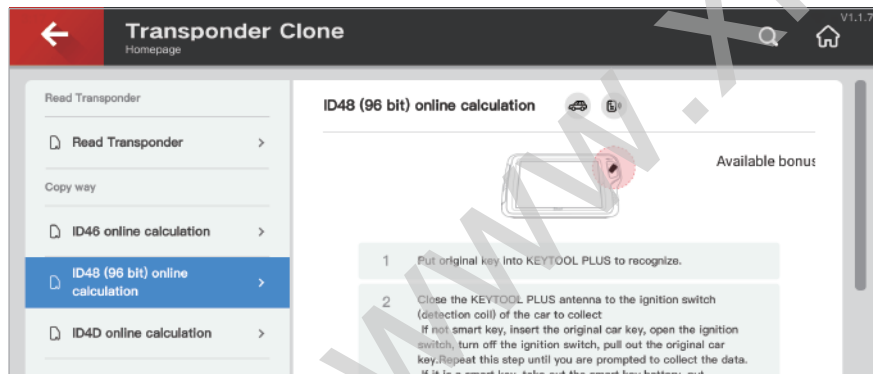

Fig.6.2.2

Some vehicle remote needs a specialized transponder when matching. KEY TOOL PLUS can convert Xhorse super transponder into common car model's transponder. See Fig. 6.2.3, the super transponder is converted into a Toyota Corolla 8A chip.

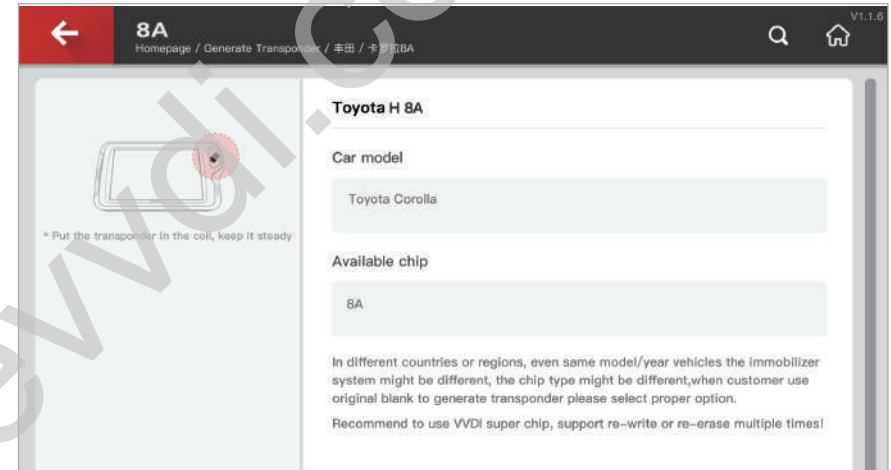

Fig.6.2.3

6.3 Special functions

As an all-in-one specialized key device for locksmiths, KEY TOOL PLUS offers a variety of practical functions like remote renew, motorcycle key unlock, car key recharge and all key lost coil detection.

6.3.1 Remote renew

Car key will be locked after programming and can not be used again. This function can unlock programmed keys of multiple brands and models as shown in Fig. 6.3.1. Renew adapters and cables are needed when operating.

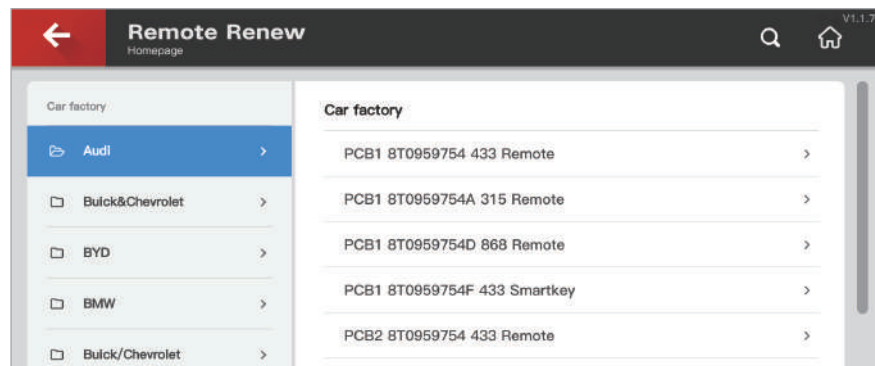

Fig.6.3.1

6.3.2 Ignition coil signal detection

When car key is undergoing all lost, you can use KEY TOOL PLUS to detect the transponder type of the car's ignition coil and whether the coil is working. You can put the antenna close to the ignition switch and turn it on and off a couple of times. Then ignition coil information will be shown on the device. See Fig. 6.3.2

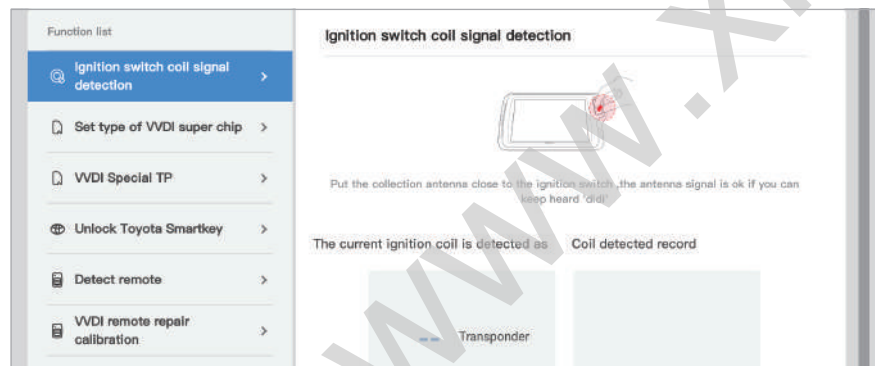

Fig.6.3.2

6.3.3 Smart key customization

KEY TOOL PLUS supports customization on Xhorse universal smart key button settings and frequency adjustment to apply to different scenarios and car models. As Fig. 6.3.3 shown, first read the smart key, then adjust relevant parameter and write the data in.

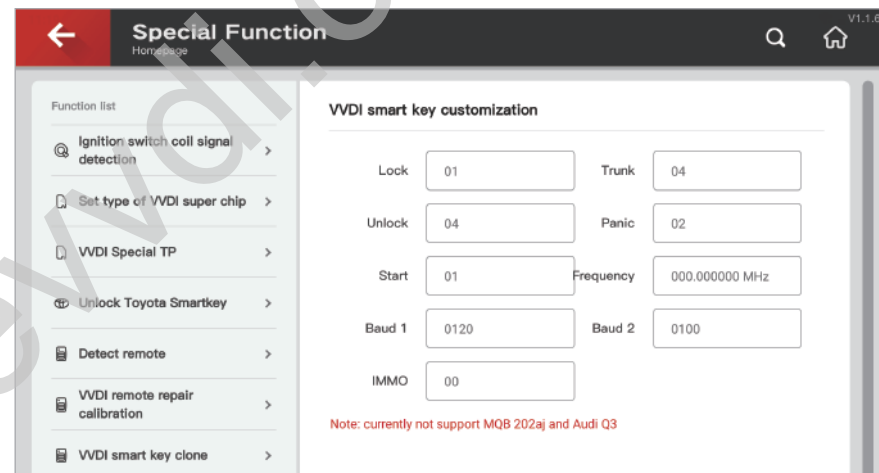

Fig.6.3.3

7 PROG

7.1 Overview

KEY TOOL PLUS supports reading and writing common modules and chips. As shown in Fig. 7.1.1, these modules include "EEPROM and FLASH", "IMMO", "Instrument", "Airbag" and "ECU". Users can operate according to the specific modules of car model or chip manufacturer.

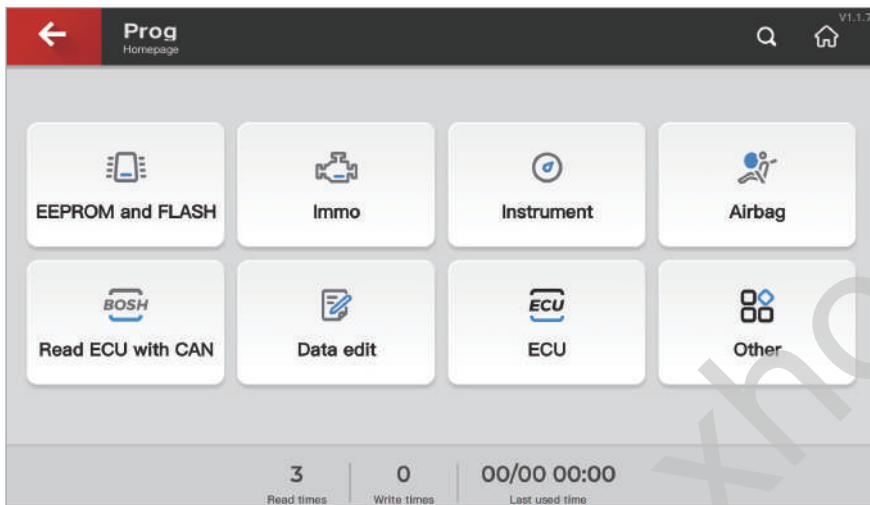

Fig.7.1.1

Note:

- ① To complete certain functions, users need to connect KEY TOOL PLUS to the specific adapters and get the required model prompt on the interface.
- ② The function is only effective on the advanced edition.

7.2 EEPROM Reading and Writing

KEY TOOL PLUS supports reading and writing EEPROM chip of ordinary cars. As shown in Fig. 7.2.1 is an example of KEY TOOL PLUS reading BMW 35160.

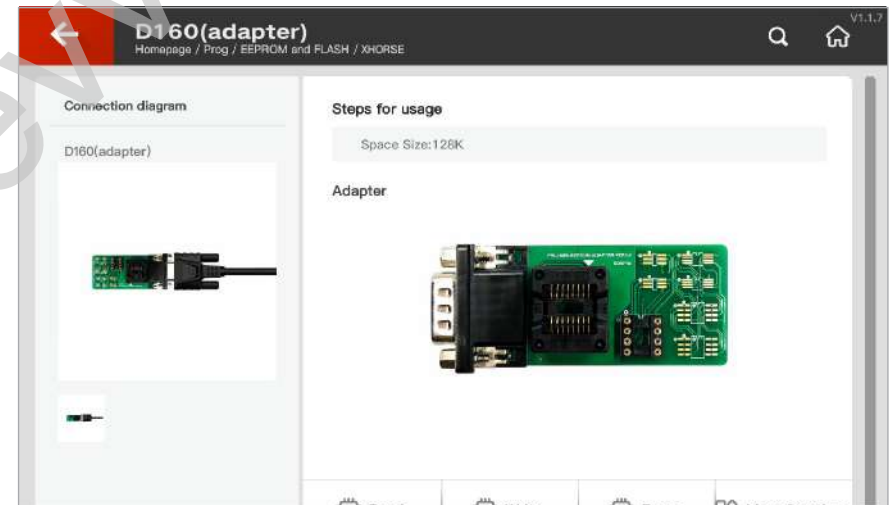

Fig.7.2.1

Steps:

- ① Connect the device to the adapter, then solder the chip to the adapter as shown in Fig. 7.2.2.
- ② Execute reading, writing or other operations.

7.3 BMW FRM module programming(Solder-Free)

Steps:

① Connect the device to BMW adapter(Optional), then clip the adapter to BMW FRM module as shown in Fig. 7.3.1.

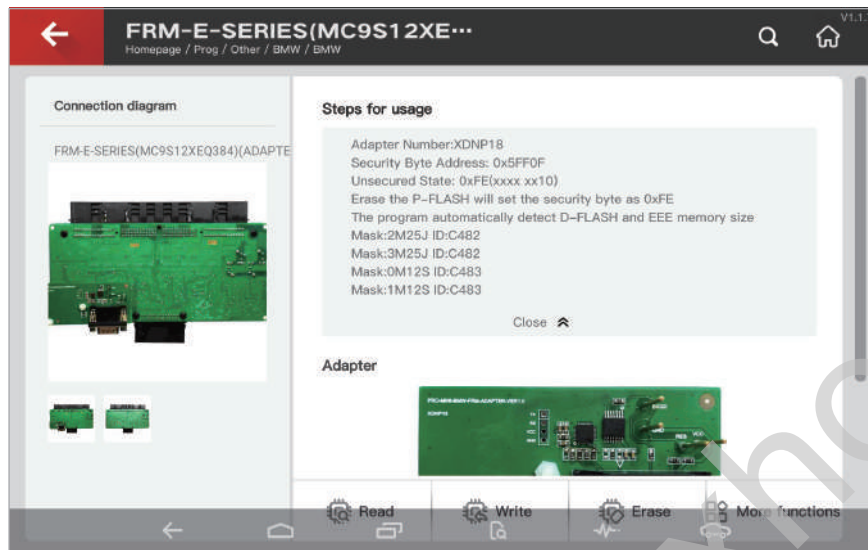

Fig.7.3.1

② Execute reading range and data, then write the repaired data.

7.4 LANDROVER RFA programming(Solder-Free)

Steps:

① Connect the device to Land Rover RFA adapter(Optional), then clip the adapter to Land Rover RFA module as shown in Fig. 7.4.1.



Fig.7.4.1

② Execute unlock, reading and other operations.

7.5 PORSCHE BCM programming(Solder-Free)

Steps:

① Connect the device to Porsche BCM adapter(Optional), then clip the adaptor to Porsche BCM module as shown in Fig. 7.5.1.

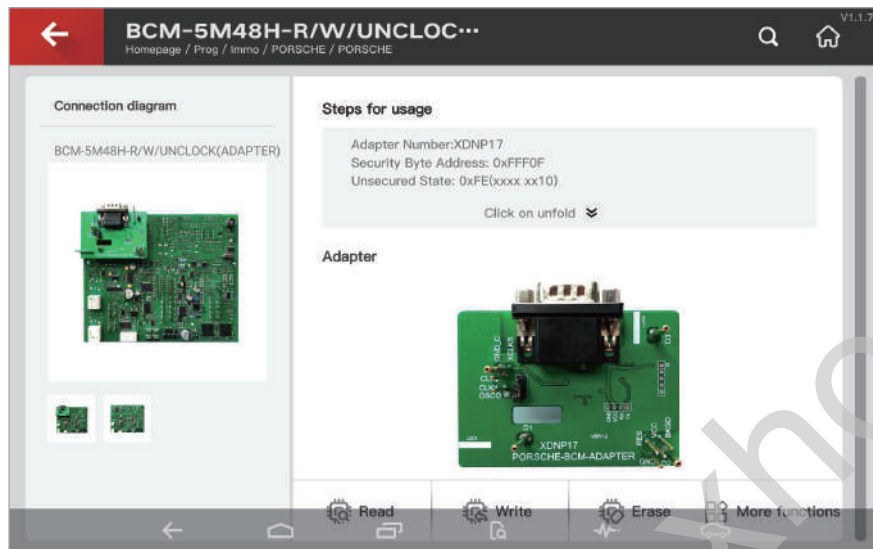

Fig.7.5.1

② Execute backup reading and other operations.

8 Immo Data Tool

For some cars, key programming and other settings can't be finished via OBD port due to its immobilizer system design. On this occasion, File Make Key can be used to generate or add keys for them. The primary principle of File Make Key is to generate transponder via reading related transponder data of the car immo module directly. Thus the car can be started without programming.

8.1 Car models support list

KEY TOOL PLUS supports File Make Key function of common cars and motorcycles. The support list is as follows in Fig. 8.1.1.

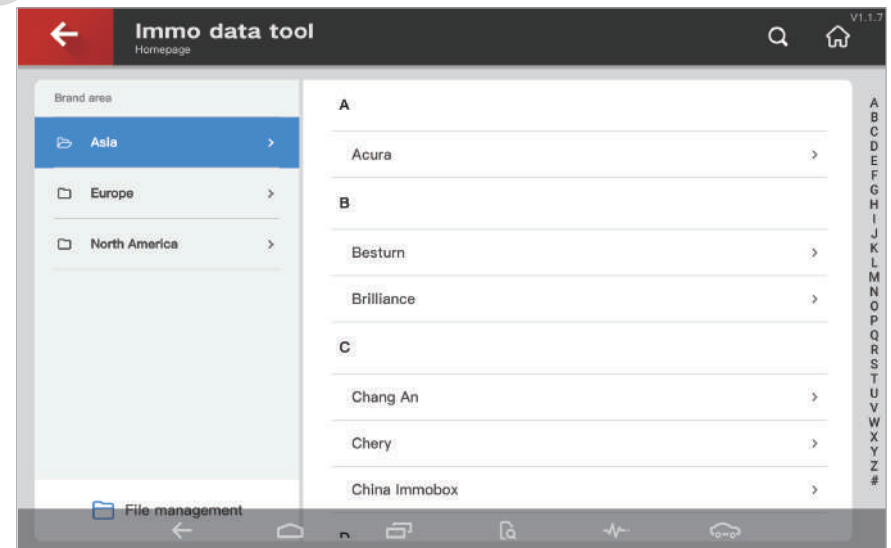

Fig.8.1.1

8.2 Magotan/CC 48 transponder File Make Key

File Make Key requires reading the car's module data. Firstly, you can use PROG function (see Chapter 7) to read the data of comfort computer for later use and finish the following steps.

Steps:

- 1 Choose VW/Magotan, CC ID48– 95320 option as shown in Fig. 8.2.1.

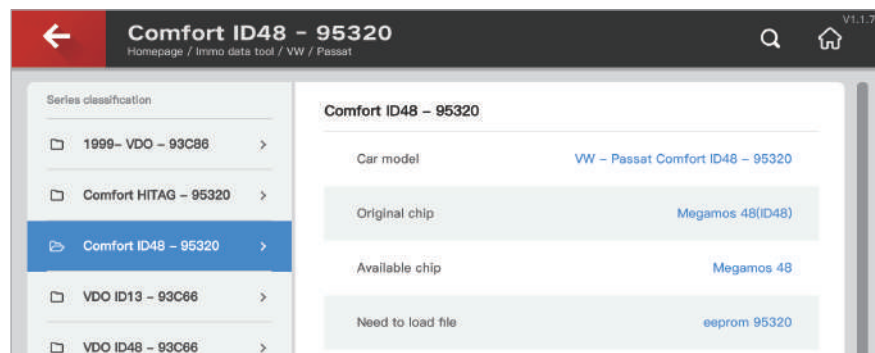

Fig.8.2.1

- 2 Load the original file of comfort computer that has been read, then generate dealer key or working key.

- 3 Test the key in car. Please note that some models need to write data back to EEPROM via PROG function (see Chapter 7) and then you can test the key in car.

8.3 File management

KEY TOOL PLUS offers file management, in which you can choose data in local file or my data (online cloud data file) in File Make Key process as shown in Fig. 8.3.1.

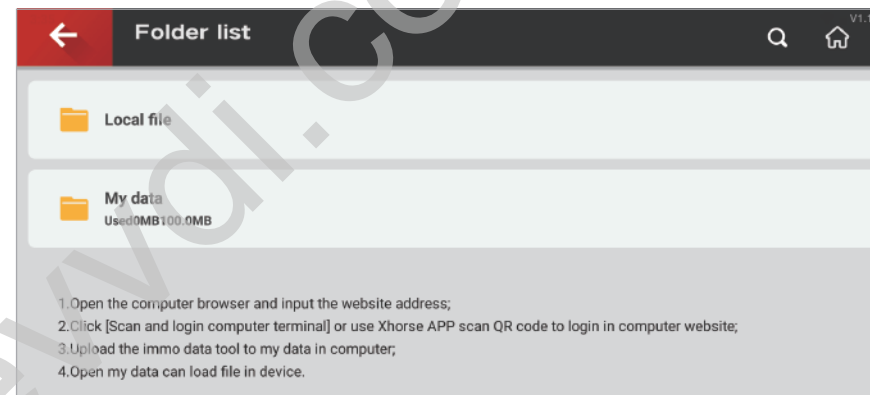

Fig.8.3.1

Local file: File reading from PROG function of KEY TOOL PLUS or file downloaded and stored in the device.

My data: Cloud file uploaded through other terminals.

How to upload file to cloud server:

- 1 Open <http://i.xhorse.com>
- 2 Scan the QR code to log in as shown in Fig. 8.3.2.



Fig.8.3.2

- 3 Upload file through PC.

9 Extended Function: Cutting Key

KEY TOOL PLUS can be extended to control Xhorse key cutting machines (CONDOR, DOLPHIN and Panda) and work as its screen. See the interface as shown in Fig. 9.1

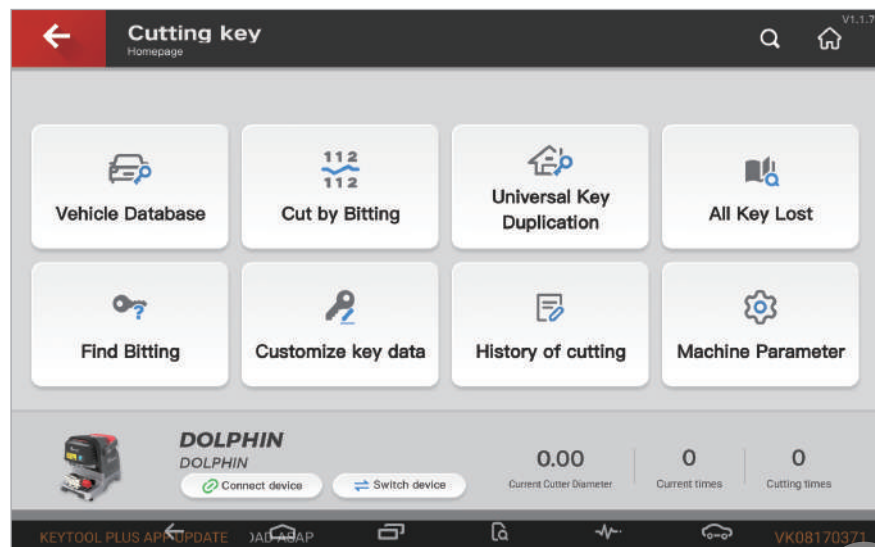

Fig.9.1

9.1 How to switch and connect the key cutting machine

Steps:

- 1 Click 'Switch device', select the machine you need as shown in Fig. 9.1.1. Machines that are compatible with KEY TOOL PLUS include DOLPHIN, MiNi PLUS, XC Mini and PANDA.



Fig.9.1.1

- 2 Click 'Search new device' and click on the serial number.

9.2 Introduction to key cutting machine functions

Vehicle Database

Vehicle Database shows all the key blanks supported by the currently connected device. You can choose the brand, model, year and key blank you need. See Fig. 9.2.1.

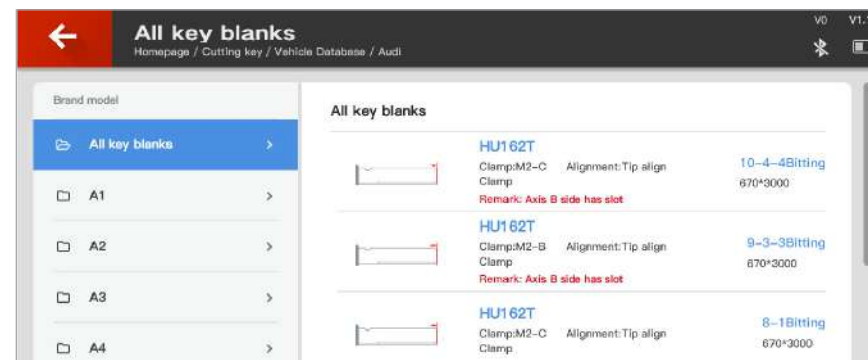

Fig.9.2.1

112 212 Cut by Biting

Cut by Biting is categorized by general key blanks. The device supports cutting by different biting. See Fig. 9.2.2

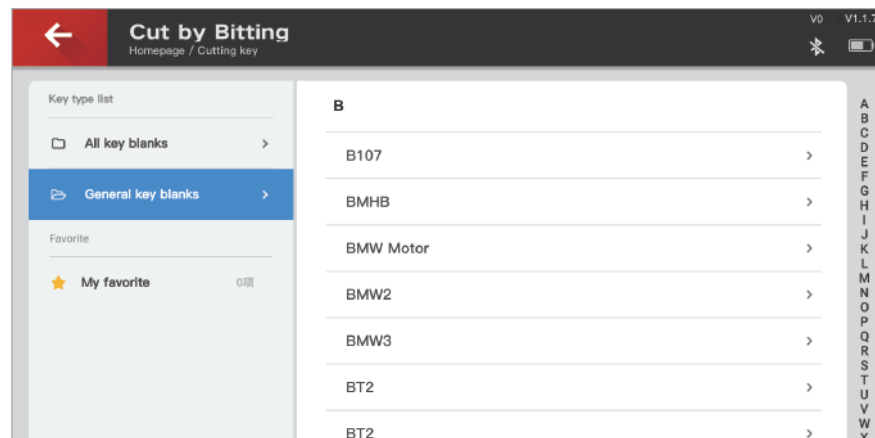

Fig.9.2.2

Universal Key Duplication

Universal Key Duplication can copy six common car key's biting. Usually, it's used when you don't have the key cutting data of the model. See Fig. 9.2.3

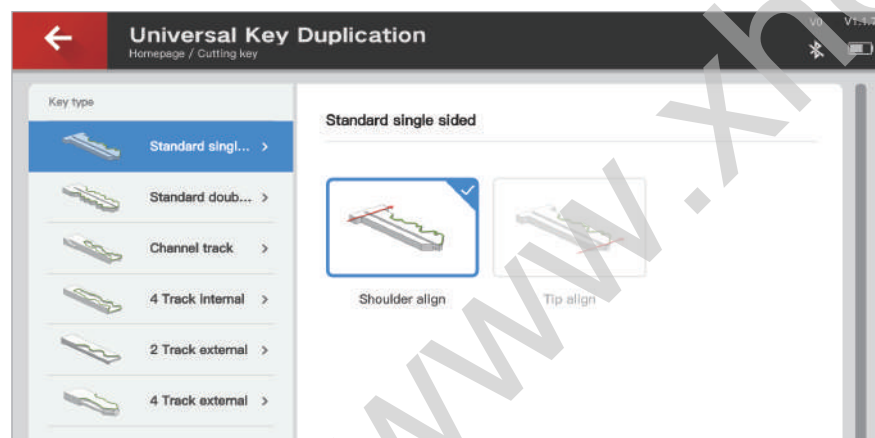

Fig.9.2.3

All Key Lost

All Key Lost can help you get the biting when you have partial key information like key tag, key code of car lock and such. See Fig. 9.2.4, you can acquire the car's biting by entering related information.



Fig.9.2.4

Find Biting

For some cars, the ignition lock has more bitings than the car door lock. After you acquire the car door lock's biting, you can use find biting function to get all of the ignition lock's biting.

Customize Key Data

For those key biting that is not supported by the key cutting machine temporarily, users are encouraged to customize key data or download biting data uploaded by other users in the sharing market.



Machine Parameter

Machine Parameter supports the initialized setting and adjustment of the key cutting machine.

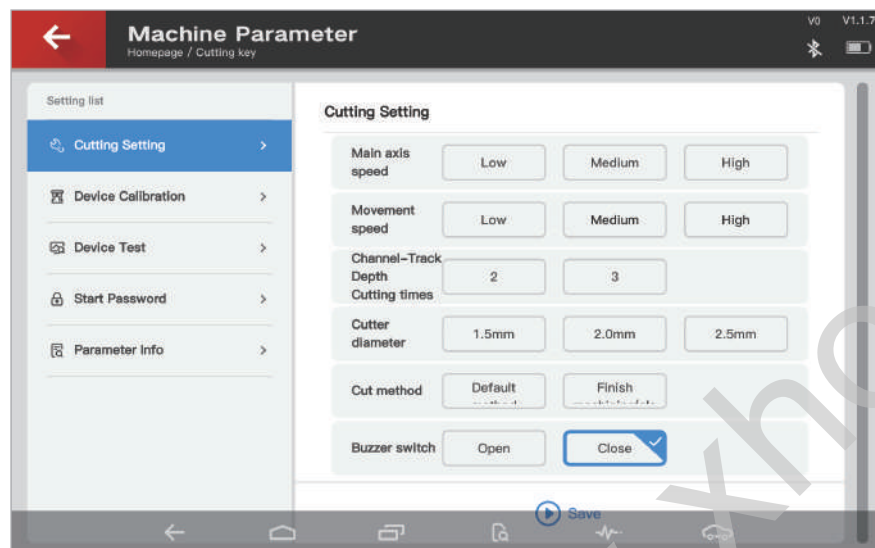

Fig.9.2.5

10 Settings

General Setting page can be entered through the shortcut button of setting as shown in Fig. 10.1.

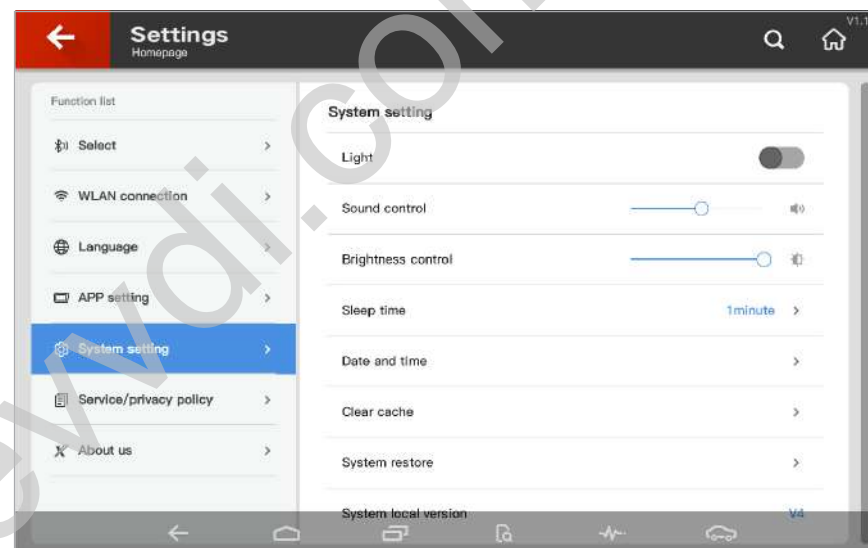

Fig.10.1

10.1 Select

This option is for connecting the key cutting machine via Bluetooth. The device can connect to a key cutting machine after you select the serial number.

Steps:

- ① Click 'Search new device'.
- ② Click the serial number and the machine is connected then.

10.2 WLAN connection

This option is for searching and connecting to WIFI.

Steps:

- ① Click 'Scan'.
- ② Choose the WIFI you want and enter the password. Key TOOL PLUS will connect to WIFI then automatically.

10.3 Language setting

This option can change the language of the device.

Note: Languages supported differ in different areas.

10.4 APP setting

This option shows APP voice prompt switch and update information.

10.5 System setting

This option is for the general function setting of the device. As Fig. 10.1 shown, you can adjust the system volume, brightness, sleep time, clear cache and restore system.

10.6 Service/privacy policy

This option shows the full version of the service agreement. To use KEY TOOL PLUS, you have to agree and follow the Service/Privacy Policy first.

10.7 About us

This option shows manufacturer information and the current APP version of the device.

11 Warranty and After-sales Service

Xhorse offers a guarantee period of one year which starts from the purchasing date. If there is no invoice or the invoice is missing, purchase records from factory is used as a reference.

Below scenarios are not covered in warranty:

- Damage of device caused by operations without observing user manual
- Damage of device caused by self-repair or modification
- Damage of device caused by dropping, collision, or improper voltage
- Damage of device caused by Force Majeure
- Damage of device caused by long-term use in severe environment, in vehicle or boat
- Shell stain, scratch and abrasion caused in daily use

www.xhorsevdi.com

For after-sale service and technical support, please contact the dealer or Xhorse online customer service by scanning the QR code in the back of the manual and downloading Xhorse APP.